

Рисунки к курсу лекций МИТ



Рис.1



Рис.2

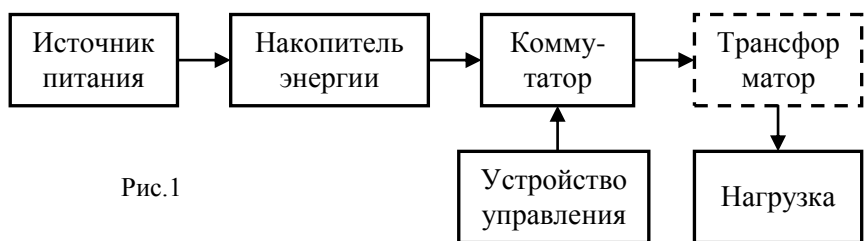

Рис.3

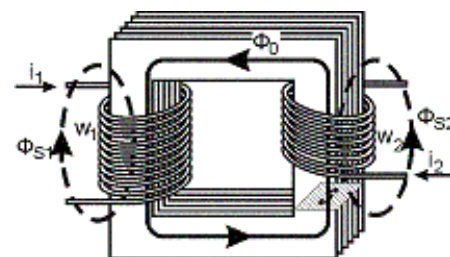

Рис.4

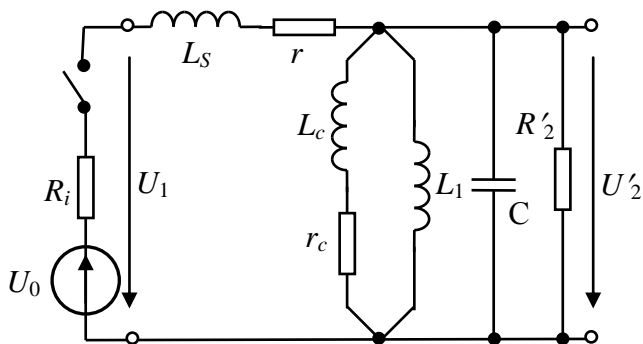

Рис.6

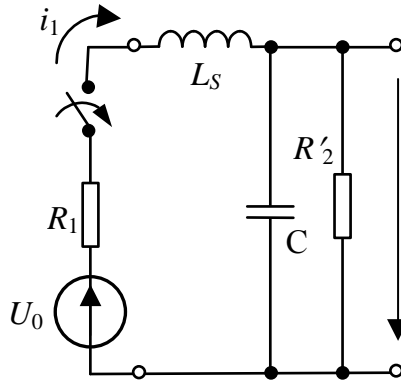

Рис.5

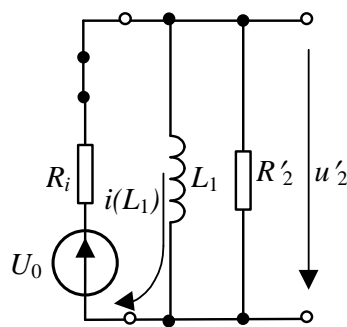

Рис.7.

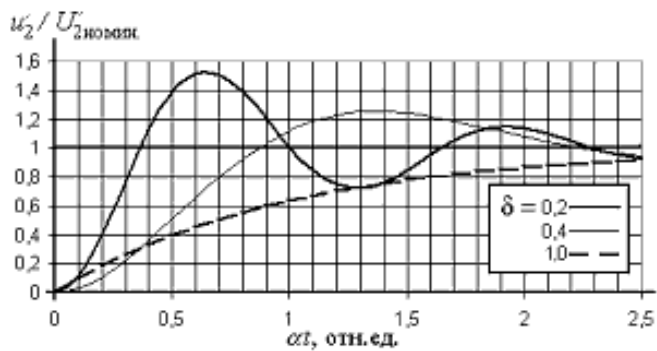

Рис.8.

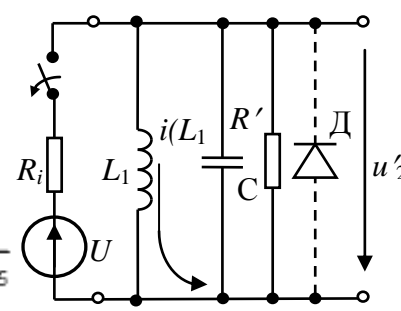

Рис.9

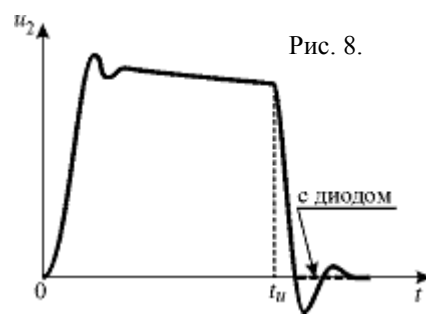

Рис.10

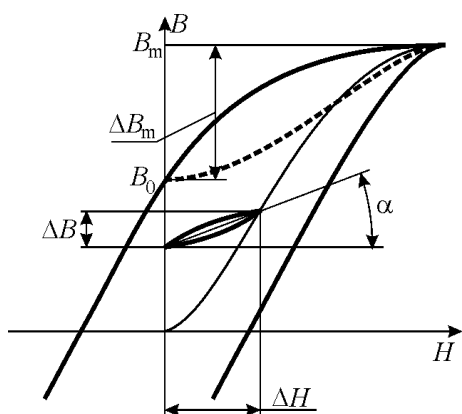

Рис.11

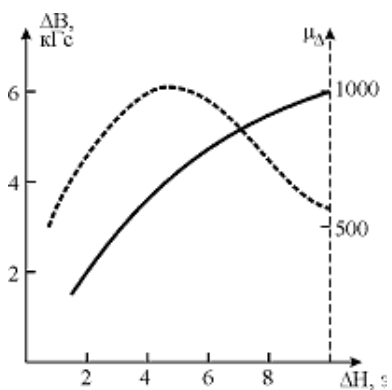

Рис.12

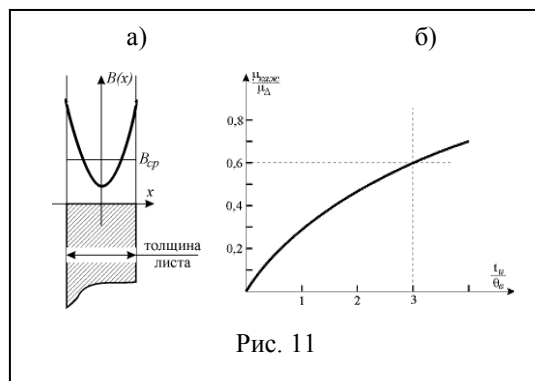

Рис. 13

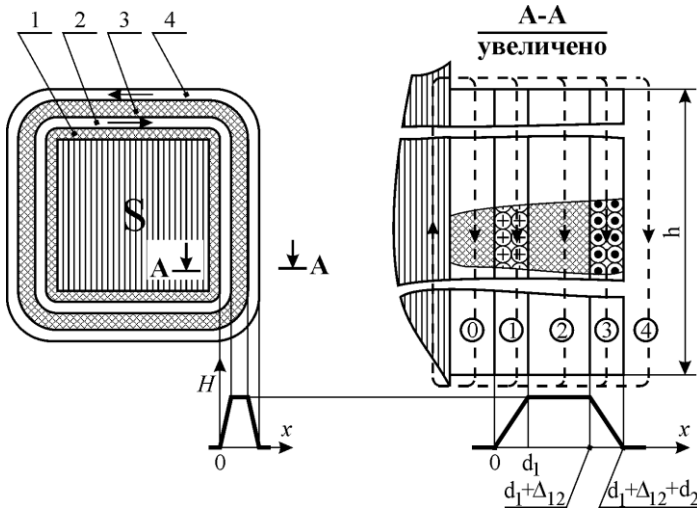

Рис.15

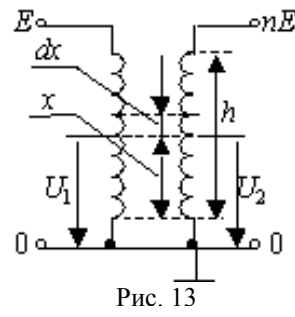

Рис. 14

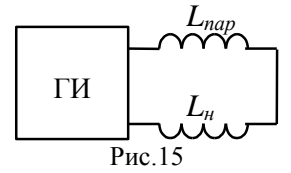

Рис.16

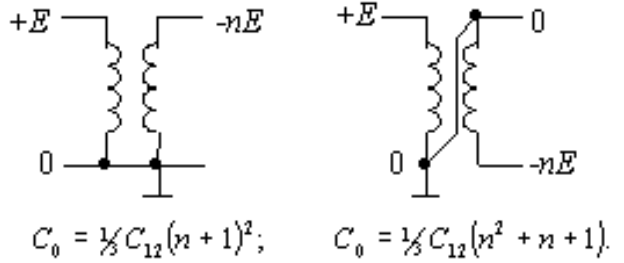

Таблица 1

Линии передачи		
однородные и неоднородные	с распределенными параметрами	коаксиальные полосковые дисковые
	промежуточные	спиральные
	с сосредоточенными параметрами	цепочечные

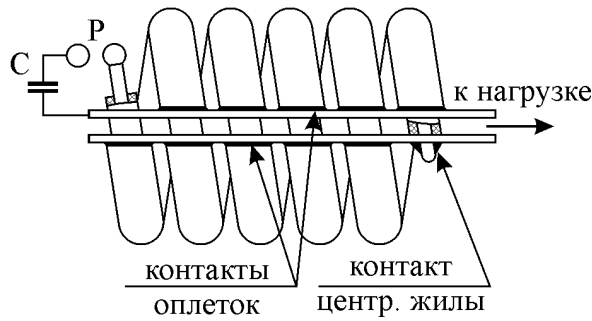
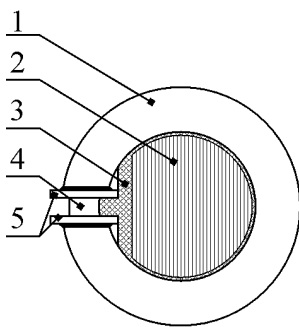
а)

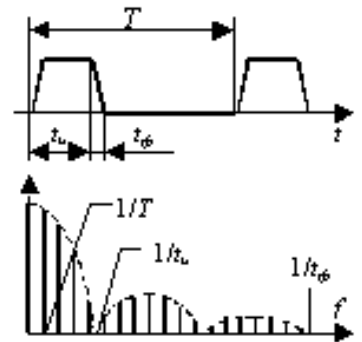
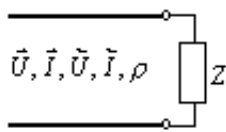

б)



Рис. 19.

Рис.17



Рис.18

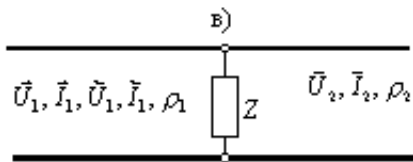
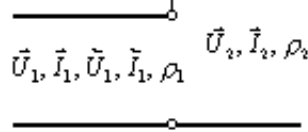

Рис.20

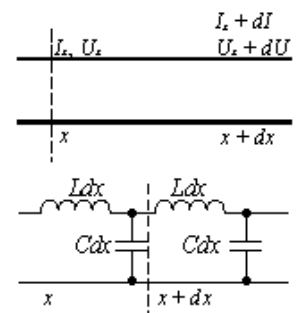

$U_{уст} = E$; $I_{уст} = \frac{E}{Z_2}$

Рис.21

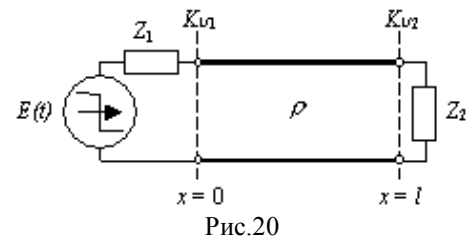
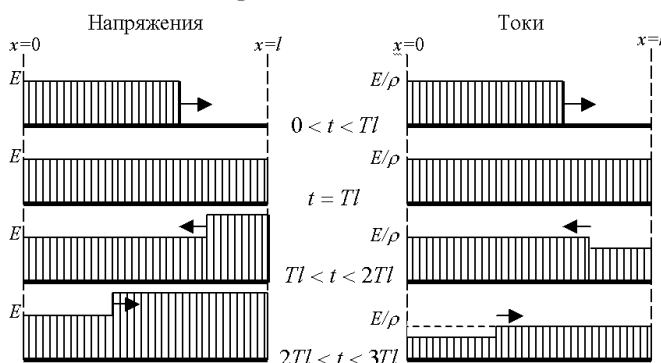

Рис. 22.

Переходные процессы в линии передачи при согласованном генераторе и разных нагрузках

№	Вид нагрузки	Напряжение на входе	Напряжение на нагрузке
1	$Z_2 = \infty$		
2	$Z_2 = 0$		
3	$Z_2 = R$		
4	$Z_2 = 1/pC$		
5	$Z_2 = pL$		
6	$Z_2 = \frac{pCR}{1+pCR}$		
7	$Z_2 = R+pL$		

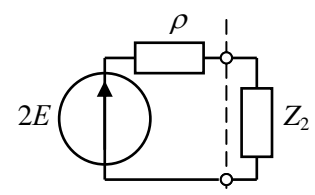

Рис. 23



Рис. 24

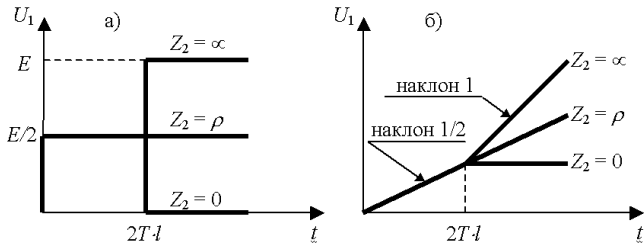

Рис. 25

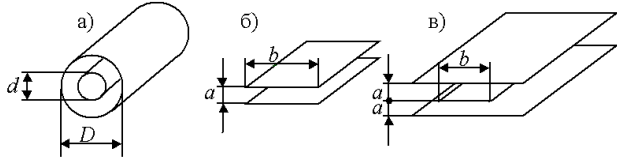

Рис. 26

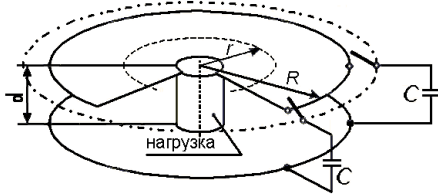

Рис. 28

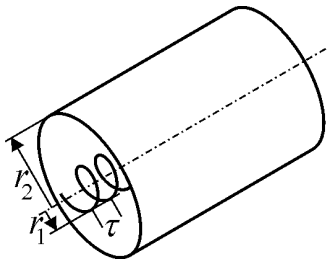

Рис. 28.2

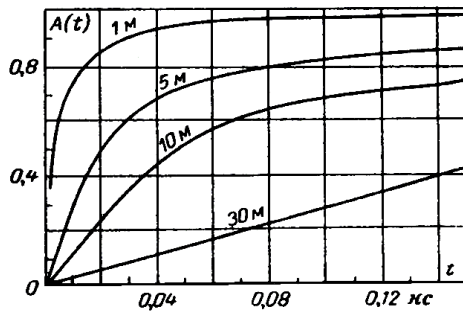

Рис. 31.

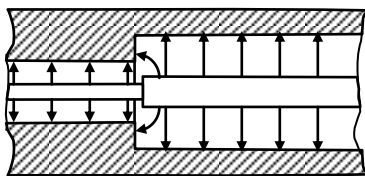

Рис. 27

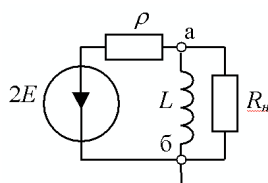

Рис. 29

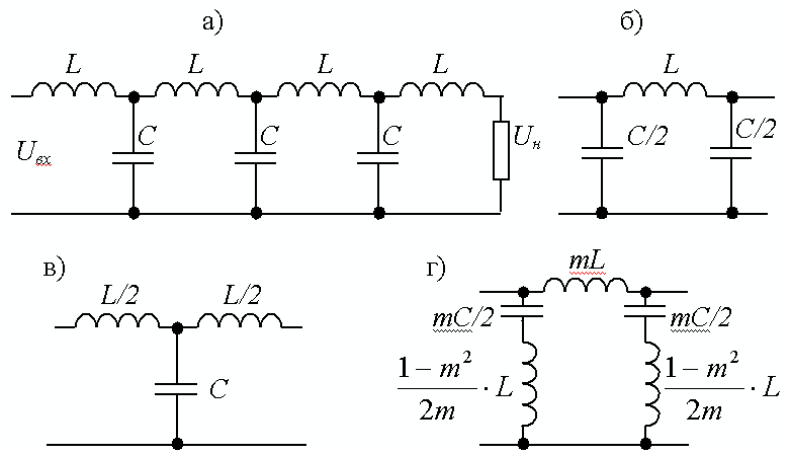

Рис. 30

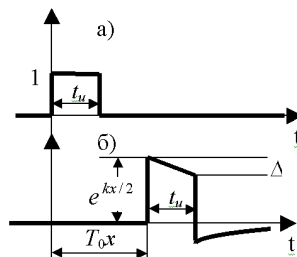

Рис. 32

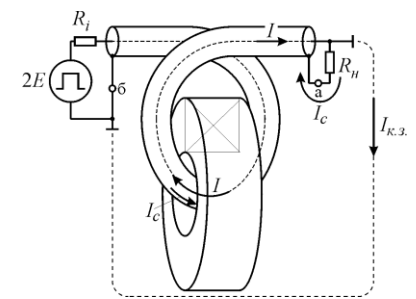

Рис. 33.

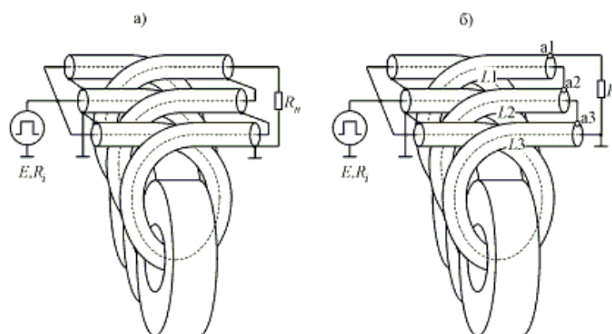

Рис. 34

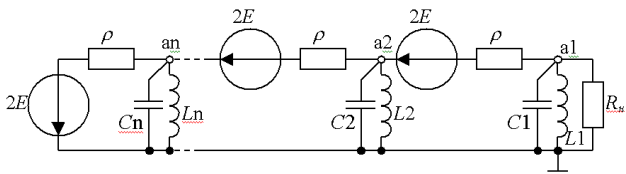

Рис. 35

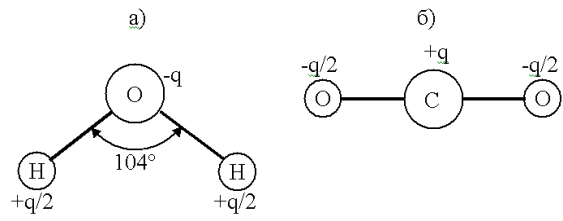

Рис. 36

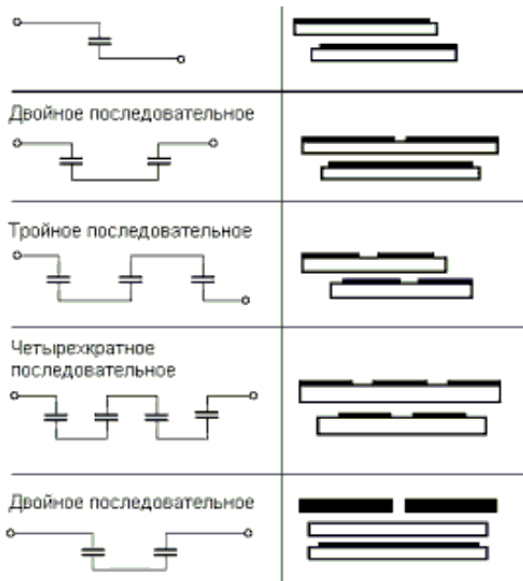

Рис. 37

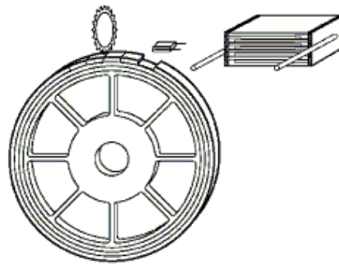

Рис. 38

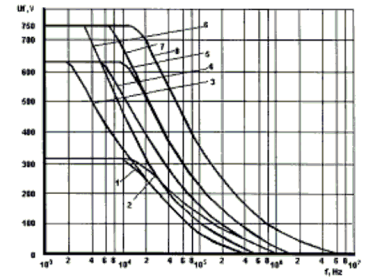

Рис. 39

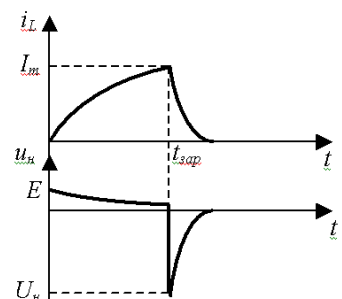
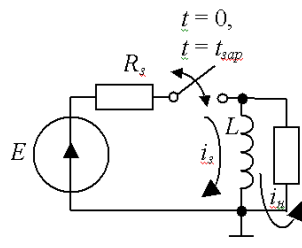

Рис. 41

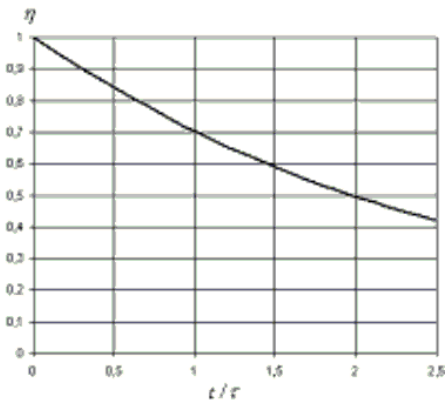

Рис. 40

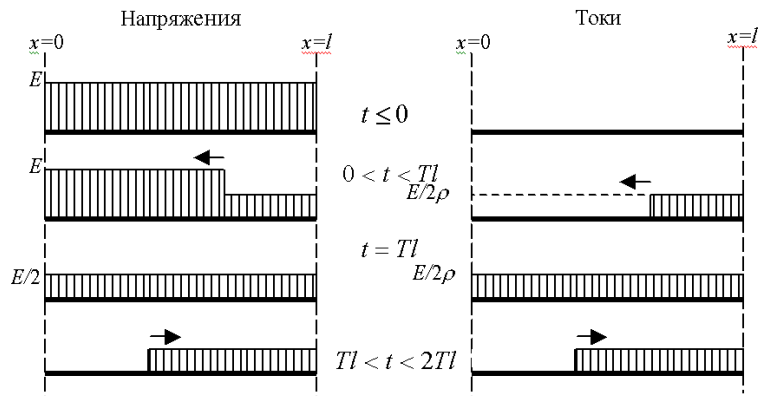

Рис. 42

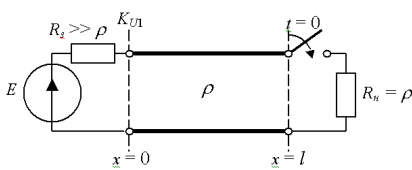

Рис. 43

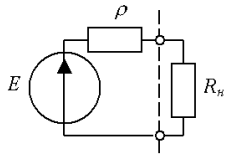

Рис. 44

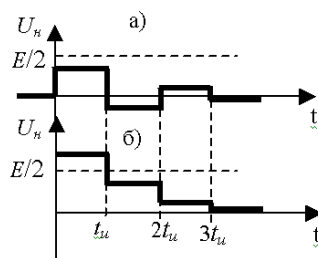

Рис. 45

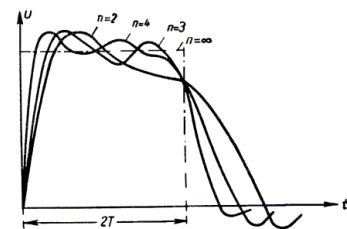

Рис. 47

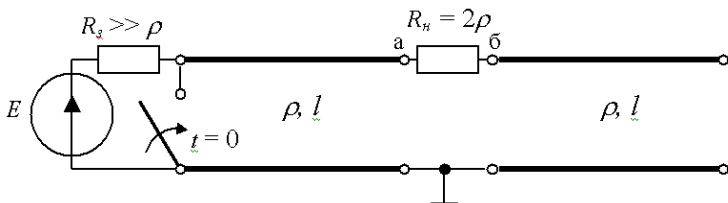

Рис. 48

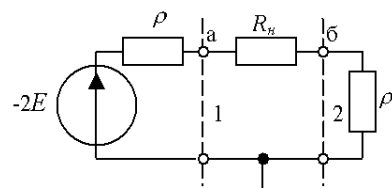

Рис. 49

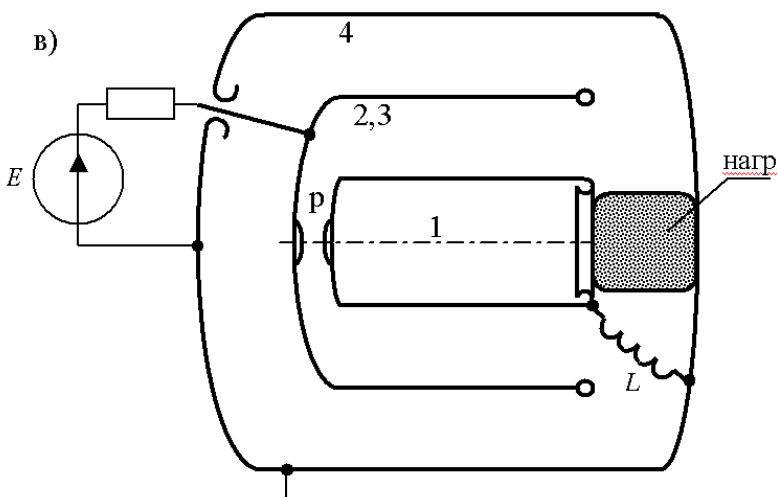
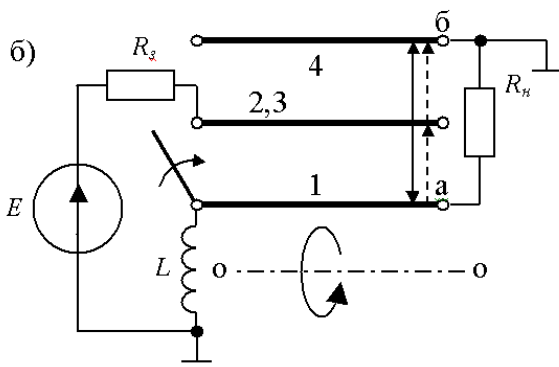
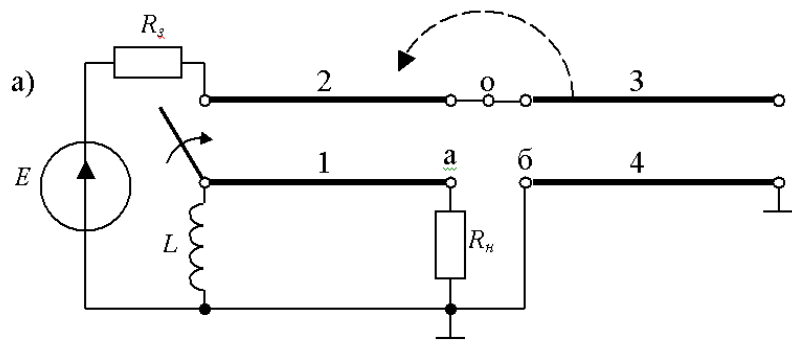
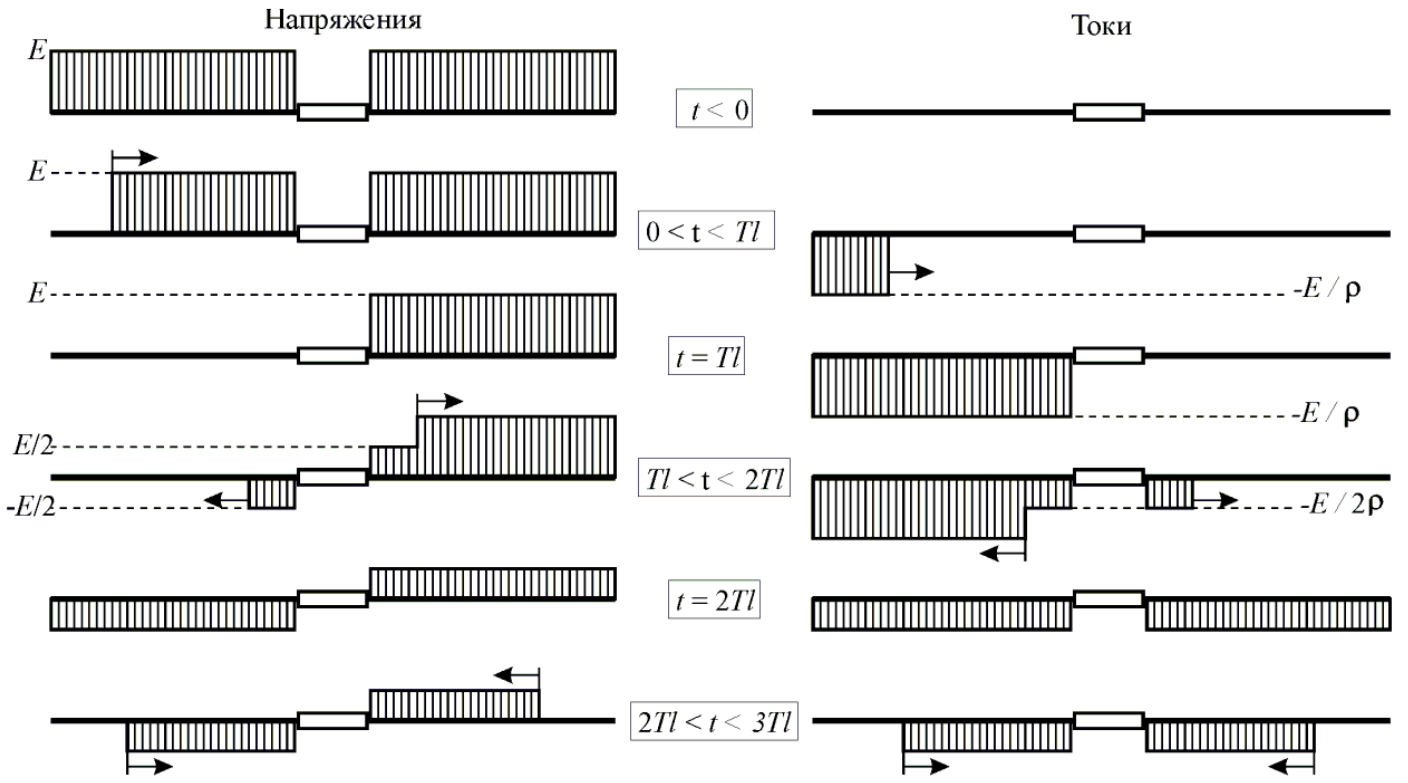

Рис. 50

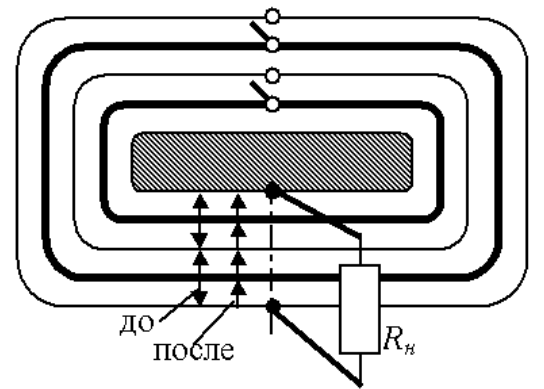

Рис.51

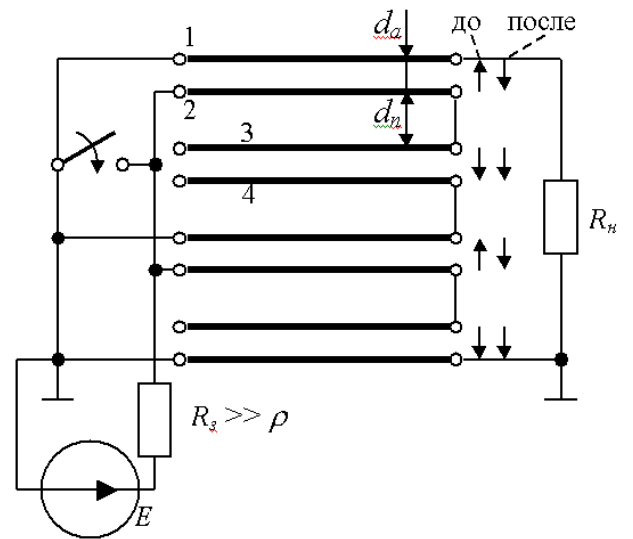

Рис.52

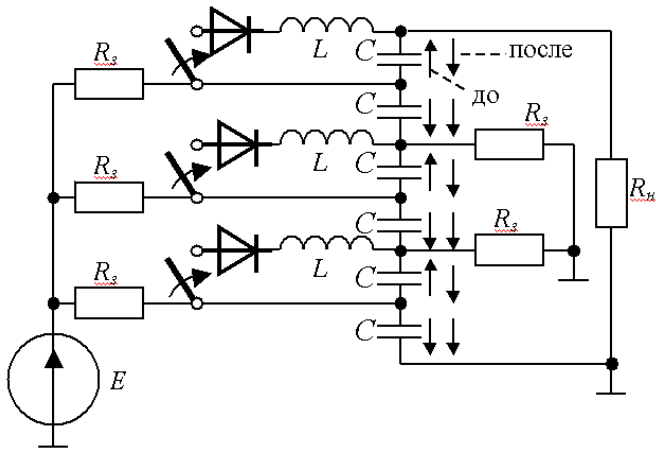

Рис. 53

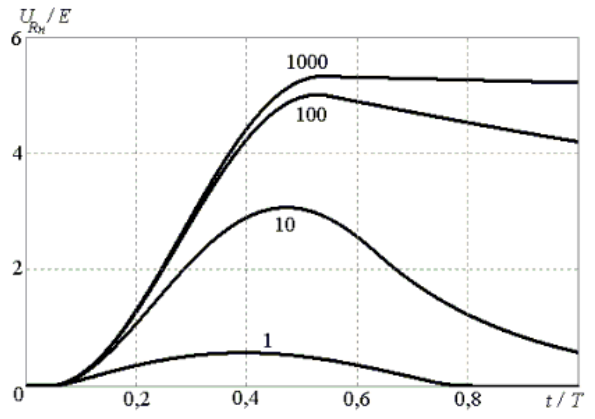

Рис.54

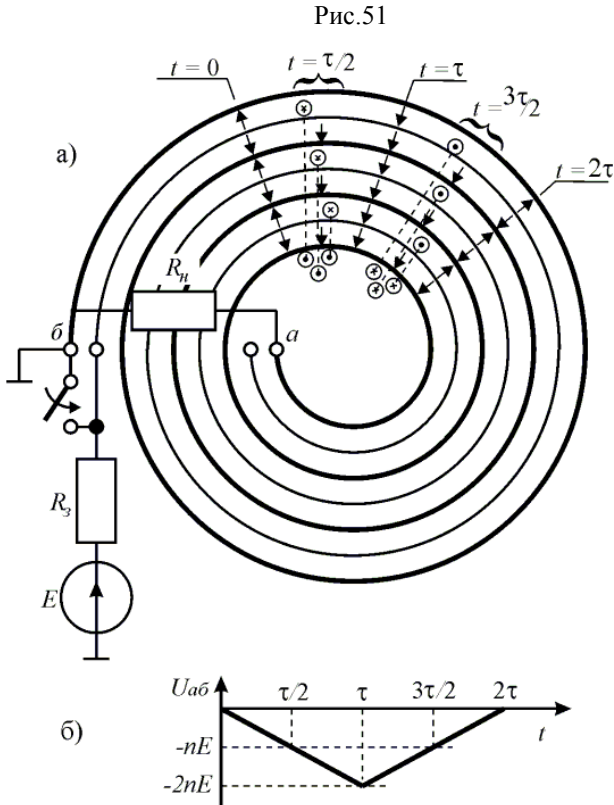

Рис.55

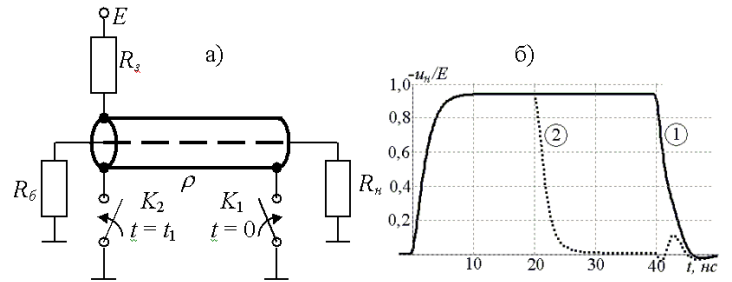

Рис.56

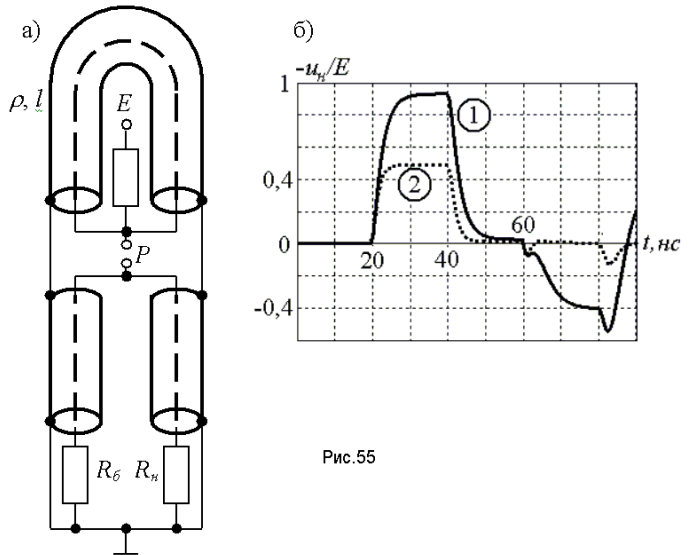

Рис.58

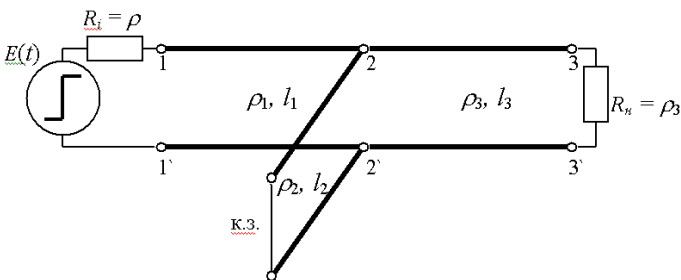

Рис. 57.



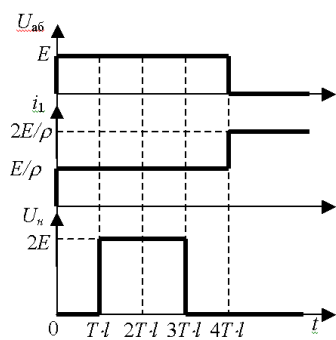

Рис.59

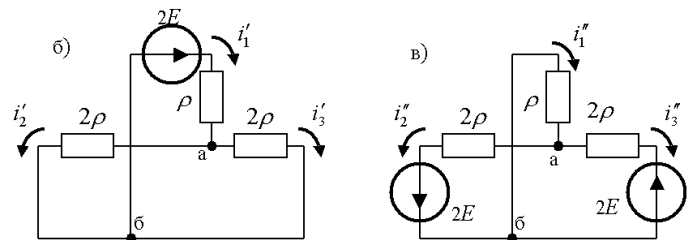
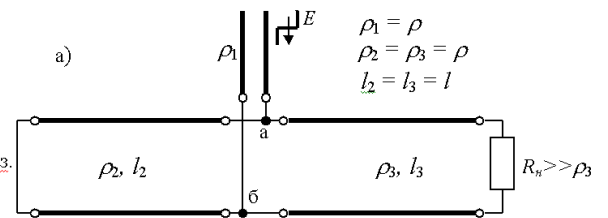
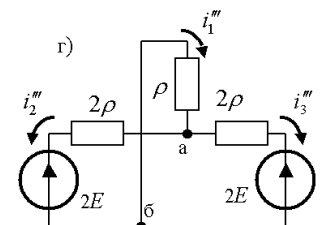

Рис.60

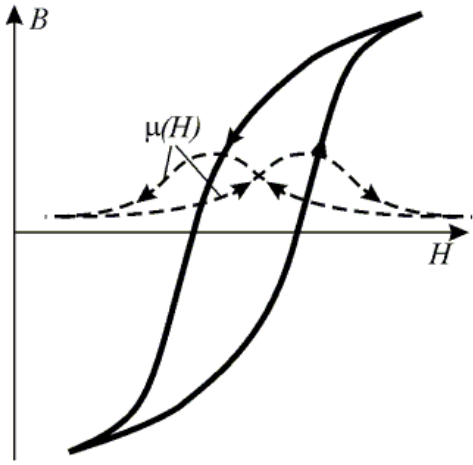

Рис.61

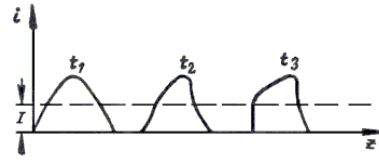

Рис.62

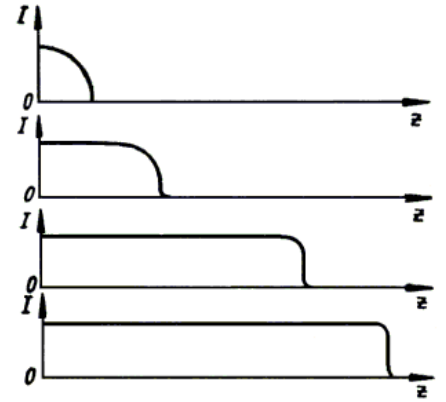
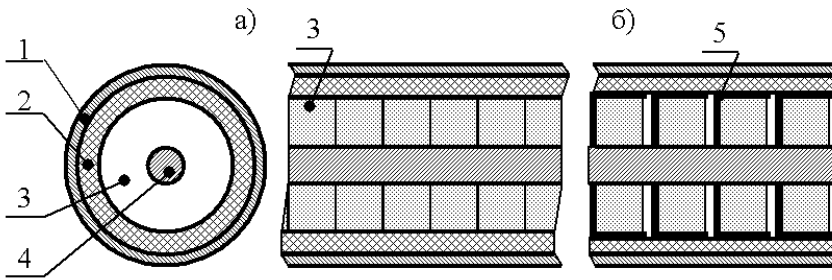
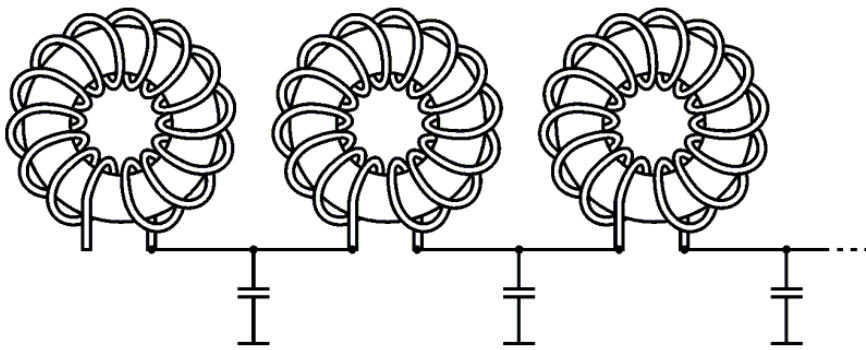

Рис.63